

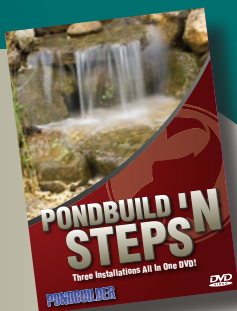

PONDBUILD 'N STEPS 'N



Purchase the PondBuild 'n Steps DVD from your local dealer or online at www.pondbuilder.com and watch an Elite Cascade Installation step by step.

**Cascading Falls
Installation Manual**

PONDBUILDER

Item #PBSCF



22" Elite Kit Shown

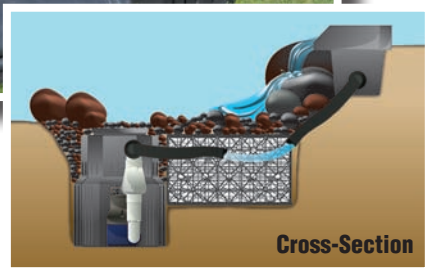

Cross-Section



STEP 1

Unpack Kit & Assemble Matrix Box:

The first step towards building your new water feature is to remove all products from the kit box. Next, assemble the basin matrix box by laying one of the largest panels on the ground. Each of the four smallest panels can then be pushed into position by hand, noting that two of the panels will make the ends of the box. The other two will provide weight support for the rockwork. Next, take the largest remaining panel and snap it into place to create the top of the box. Finally, the two remaining panels will create the sides of the matrix box. The kit type purchased will determine the number and size of matrix boxes you will have in the kit.



STEP 2

Excavate Basin Area:

Set the basin matrix box/boxes and pump canyon into position and mark accordingly so you'll know how big of an area to excavate. Refer to the back page for basin size and depth recommendations based on the size of kit being installed. At this time it's a good idea to determine the placement of the Cascade Box and the path that the waterfall & stream will take to enter into the basin. Spray paint will help keep a visual reference of what you are working toward. Next, dig the basin area to the correct size and depth. You can use the excavated soil to build up your waterfall & stream. Complete the basin excavation by digging the area where the pump canyon will be located. Remember to call your local utility company prior to digging to ensure there are no pipes & cables in the area. Remove any roots and/or sharp edges so they won't puncture the rubber liner.



STEP 3

Install Protective Underliner & Rubber Liner:

Unfold the protective underliner and lay it in the basin. Work your way from the bottom out to ensure the underliner is installed properly. Trim off any excess underliner but keep it as we'll be using that shortly. Next, unfold the rubber liner and lay it in the basin on top of the underliner. Again, work from the bottom of the basin out. If you've purchased one of the smaller kits you'll be using one liner for the basin area and to create the waterfall and streambed so it is best to install the liner so that you have a 6" overhang all around the basin with the rest of the liner being used to create the waterfall and stream. On the larger kits, however, you'll have a basin liner that is separate from the waterfall/stream bed liner. Install the basin liner so that it's square within the basin. Next, lay the excess underliner you cut off earlier on top of the liner. This will create a cushion between the liner and the matrix box.



STEP 4

Install Pump Canyon and Matrix Box:

Now that you have the underliner and liner installed it's time to place the basin matrix boxes and pump canyon into position. Note that you will want to position the pump canyon with the discharge hole facing towards the side of the feature where the flexible hose will be placed.



STEP 5

Lay Hose & Install Pump:

Begin by laying the black flexible hose into position. Place one end of the flexible hose into the hole provided on the side of the pump canyon. Unwind the hose up towards the Cascade Box and cut off any excess. Using a clockwise motion thread the check valve assembly onto the pump. Next, you'll want to set the pump inside the pump canyon and connect the black flexible hose to the pump discharge using a screw or nut driver to tighten down the hose clamps. Note the notch on the top of the pump canyon- this is where you'll bring the pump power cord through. The lid of the pump canyon can be easily snapped into place.

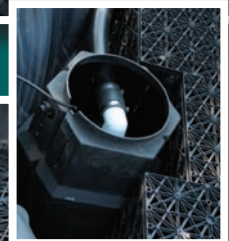

STEP 6

Finish Basin Area:

Here you'll want to fill the open areas between the matrix boxes and pump canyon with boulders. It's best to use the largest boulders near the bottom and gradually make your way up to the top with smaller boulders. Later we'll be adding a layer of gravel to finish the basin area off. Next, using topsoil or sand, back-fill all four sides of the basin area and pack down to prevent future settling.

STEP 7

Build Waterfall & Stream:

First begin by cutting out the waterfall drops you'd like to create. In most cases the soil excavated from the basin area is used to build-up the waterfall and stream area. Shape the soil to create the drops you'd like. Next, level the area that the Elite Cascade Box will be setting on. It's important that the box be installed level so that water spills out over the waterfall weir evenly.

The Elite Cascade Box is plumbed with a spin weld fitting on both ends. Your kit contains a male adapter and a threaded plug. Teflon tape the plug and thread it into the spin weld on the end that you will not be using. Teflon tape the male adapter and thread it into the spin weld on the end that you will be bringing your flexible hose into. If preferred, you can add a light bead of silicone to the fittings prior to installation. Now your Cascade box is ready to be installed.

Set the Cascade box into position and using the PVC Cement supplied install the flexible hose into the male adapter of the Cascade box. Hold it in position for 60 seconds to allow the cement to set. Note that the PVC Cement supplied with the kit is a special cement that does not require the use of primer. It is recommended, however, that you first wipe off any dirt prior to using the cement. It is a good idea to check the level of the cascade box at this point and backfill with topsoil to ensure that it stays in position.

Now you are ready to install the waterfall and stream liner (if separate from basin liner). Lay the liner so that there's enough to overlap the basin liner by at least 6" and also so that there's enough liner at the top of the waterfalls to attach to the Cascade Box. Trim any excess waterfall liner away but leave enough to tuck down into the basin. Lay the basin liner up the streambed as far as possible and then lay the waterfall liner on top of the basin liner. This will ensure water won't leak when flowing from the waterfall into the basin.

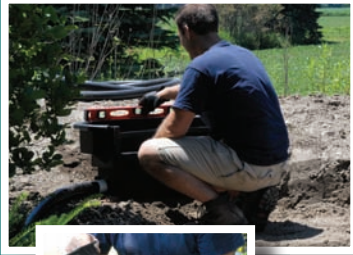



STEP 7 cont.

Next place rockwork at the end of the stream area either just in front of the matrix or if you are tight on space you can position your boulders on top of the matrix box. Complete the waterfall & stream area by adding in more rocks until completed. Don't worry if this is your first time, let the creative juices flow- if you don't like it, move some rocks around until you do! It's really simple! Again, be sure that the Cascade box remains level throughout the process so that the water flows out evenly when finished.

It's now time to attach the waterfall liner to the Elite Cascade Box. Refer to the instructions supplied with the Cascade Box for assistance.

STEP 8

Backfill Around Edges of Waterfall & Stream:

Fold back the liner along the left and right edges of the waterfall and stream and add in soil or sand to ensure that the edges are high enough that the water won't leak out. You can trim away any excess liner but we recommend leaving at least 12" along each edge and folding it back into the landscape. This will allow you to adjust if settling occurs in the future. Finish rocking the basin area and add smaller gravel to fill in the voids between the rockwork. We recommend using gravel that is 1-1.5" in size so that it won't fall through the panels of the matrix box. Using decorative gravel will create an even more dramatic display! Finish rocking in the area around the Cascade box making sure not to place any rockwork that will pull away the liner from the Cascade box. At this point you can begin filling the basin with water while you complete the rest of the steps. Along the way it's a good idea to wash off any dust from your rockwork.



STEP 8.5

Use Black Foam:

Included in some kits is a can of PondBuild 'n Foam. This foam is used to seal in and around the rockwork. This forces the water over the top of the rocks instead of around and beneath them. It greatly enhances the waterfall effect and will help to seal everything together. It's black in color and can be cut away once cured if it expands too much. Before curing completely you can sprinkle some rock dust on the foam to disguise it. If your kit did not come with any PondBuild 'n Foam, it can be purchased from your local PondBuilder Dealer.

STEP 9

Finishing Touches:

One of the coolest features of your new Cascade Box is the Landscape Lid. This lid is used to assist you in hiding the black plastic of the Cascade Box. We suggest adding in some gravel and planting creeping aquatic plants in it. Because the Landscape Lid has holes in the bottom of it the root system of the plants will always have flowing water around them. Other options for using the landscape lid include mulch, gravel, slate, or driftwood. Use your imagination! Your PondBuilder Cascade Box is the only system on the market that comes complete with the Landscape Lid!

Build up the area behind the Cascade box using rockwork and soil or gradually slope the soil back to grade. Finish all edges of the water feature by folding the liner and adding gravel, rocks, or mulch. Again, it's best to leave a little liner folded up in case of settling in the future. Next, take a flat rock and set it on top of the pump canyon lid and surround it with gravel. This will be your identifying rock when you need to access your pump.

If desired, adding aquatic plants will really help to bring your new water feature to life. Sometimes you can remove one of your boulders or rocks and put a plant in its place. This will help give your display a softer and finished look. Just make sure the aquatic plants are planted so that they will have access to water at all times.



STEP 10

Clean-Up:

The last step is to clean up the scraps and remaining materials in anticipation of running the waterfall for the first time!



Plug in Pump and Enjoy!

Plug in your pump and with great satisfaction view your very own Cascading Falls for the first time! Move some rocks around to get the water to fall exactly the way you want it. And remember, it's your waterfall, make it the way you like it.



One last thing!

When you get your feature created and you want to show it off to others, snap a hi-res picture and submit it on our website at www.pondbuilder.com. We look forward to seeing your work of art on our website soon!

www.pondbuilder.com

BASIN LAYOUTS

14" Kit

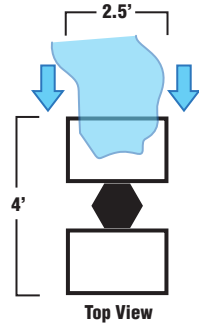
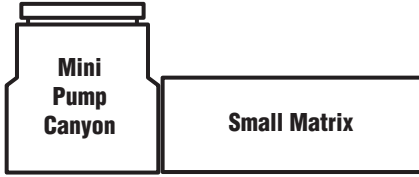

22" Kit

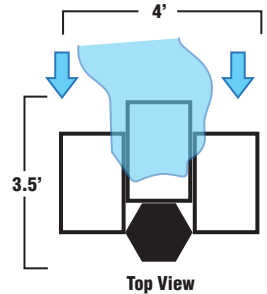
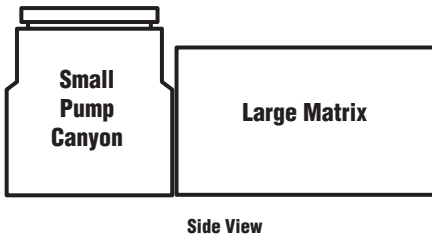

30" Kit

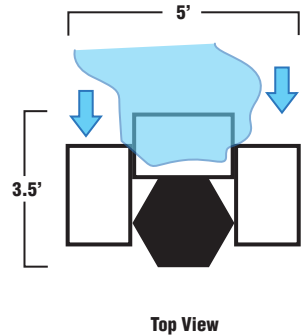
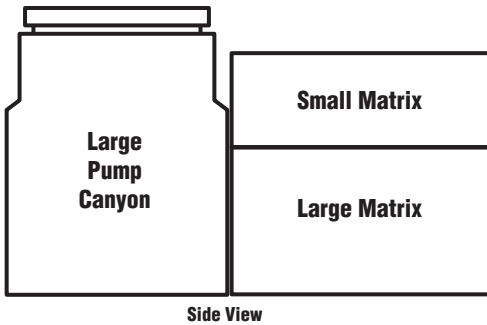

40" Kit

